

Submersible Pump HWP2 spare parts list

From Serial No. 6459

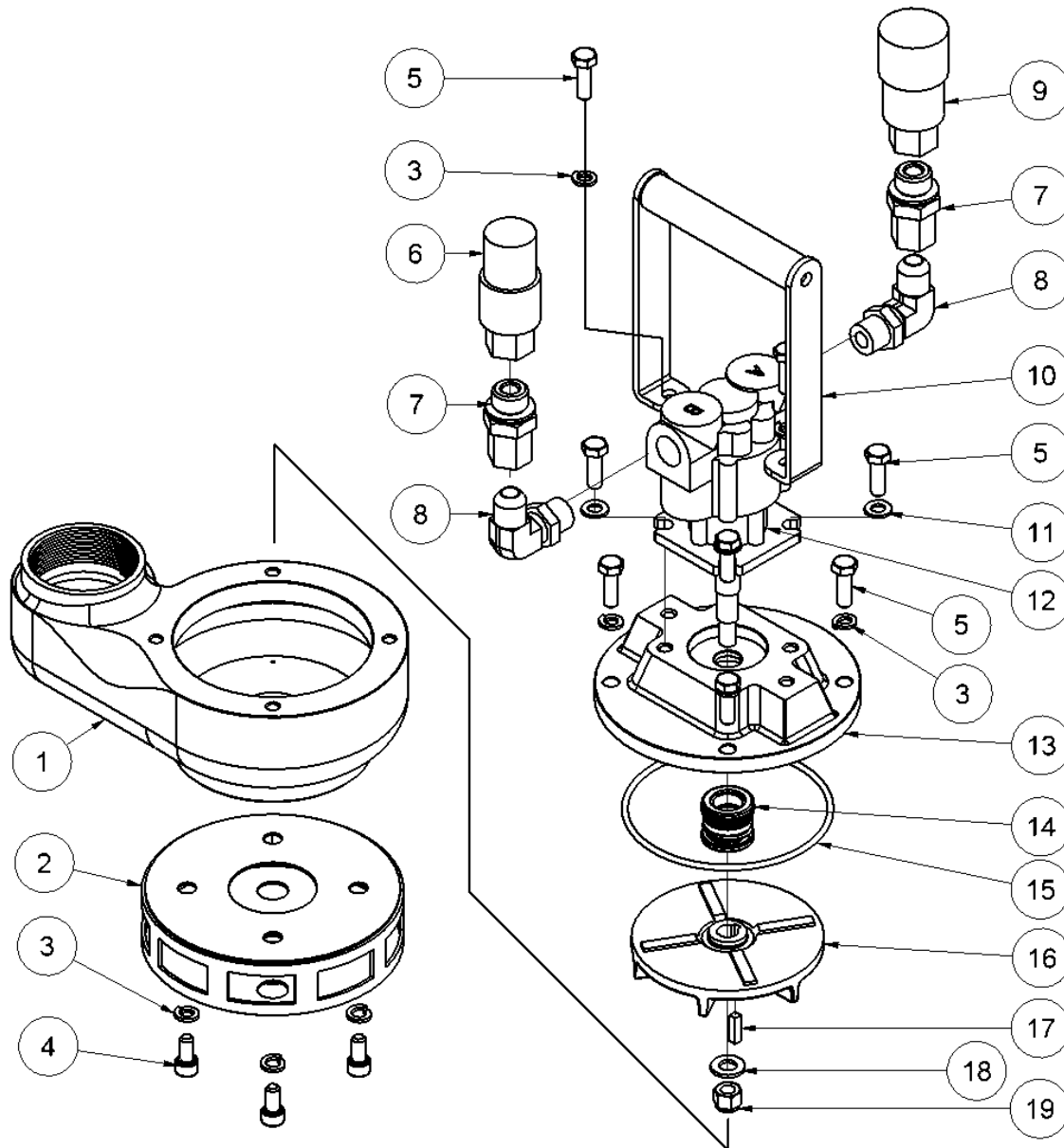

Pos.	Part No.	Description	Pcs.
1	8232700	Volute 2", aluminium	1
2	9931522	Strainer	1
3	7632618	Lock washer M8	10
4	7632621	Screw M8x16 20 Nm	4
5	7632617	Screw M8x25 25 Nm	10
6	7401141	Q.R. coupling 1/2" BSP male	1
7	7431168	Straight fitting	2
8	7431167	Elbow fitting	2
9	7401142	Q.R. coupling 1/2" BSP female	1
10	9931508	Handle	1
11	7632622	Washer M8	4
12	9931511	Hydraulic motor	1
13	8232702	Top cover 2", aluminium	1
14	9931533	Mechanical seal assembly	1
15	9931515	O-ring f/top cover	1
16	9931517	Impeller	1
17	9931518	Shaft key	1
18	9931519	Washer	1
19	9931520	Lock nut 25 Nm	1
-	9931523	Seal kit motor w/bearings	1
-	9031552	Seal kit motor	1

Submersible Pump HWP3 spare parts list

From Serial No. 6364

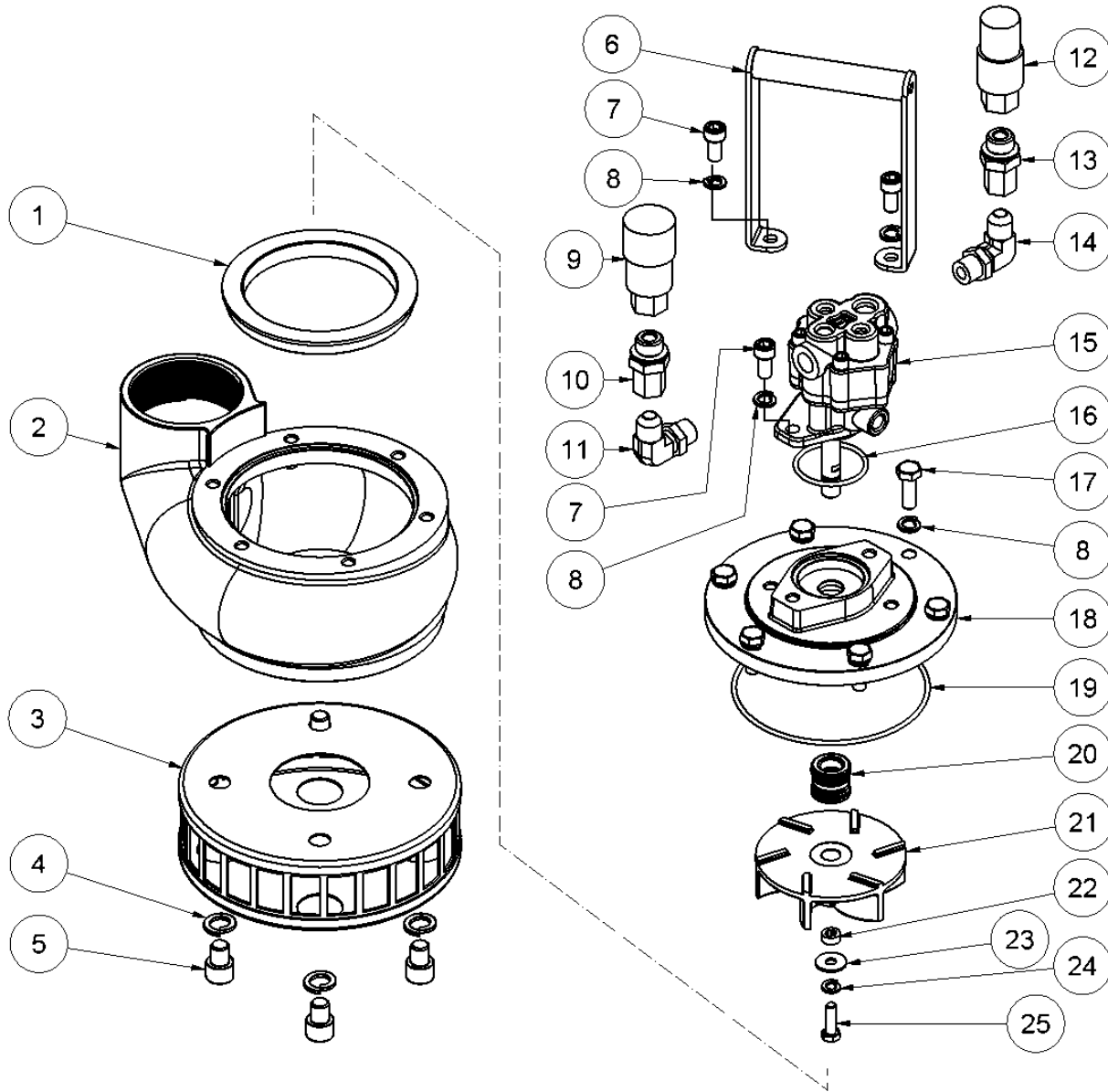

Pos.	Part No.	Description	Pcs.
1	9931529	Wear ring	1
2	8232701	Volute 3", aluminium	1
3	9931527	Strainer	1
4	7632624	Lock washer M14	4
5	7632623	Screw M14x16 60 Nm	4
6	9931542	Handle	1
7	7632631	Screw M10x20 36 Nm	4
8	7632630	Lock washer M10	10
9	7401142	Q.R. coupling 1/2" BSP female	1
10	7431168	Straight fitting	1
11	7431167	Elbow fitting	1
12	7401141	Q.R. coupling 1/2" BSP male	1
13	7431185	Straight fitting	1
14	7431184	Elbow fitting	1
15	9931545	Hydraulic motor	1
16	9931538	O-ring f/motor	1
17	7632629	Screw M10x30 40 Nm	6
18	8232628	Top cover 3", aluminium	1
19	9931534	O-ring f/top cover	1
20	9931533	Mechanical seal assembly	1
21	8232627	Impeller 3" <i>Grease on the inside with copper paste</i>	1
22	8232632	Lock screw f/impeller 30 Nm	1
23	7632626	Washer M8	1
24	7632618	Lock washer M8	1
25	7632625	Screw UNC 5/16x1" 25 Nm	1
-	9931546	Seal kit motor	1
-	9931547	Seal motor shaft	1

Submersible Pump HWP4 spare parts list

From Serial No. 6597

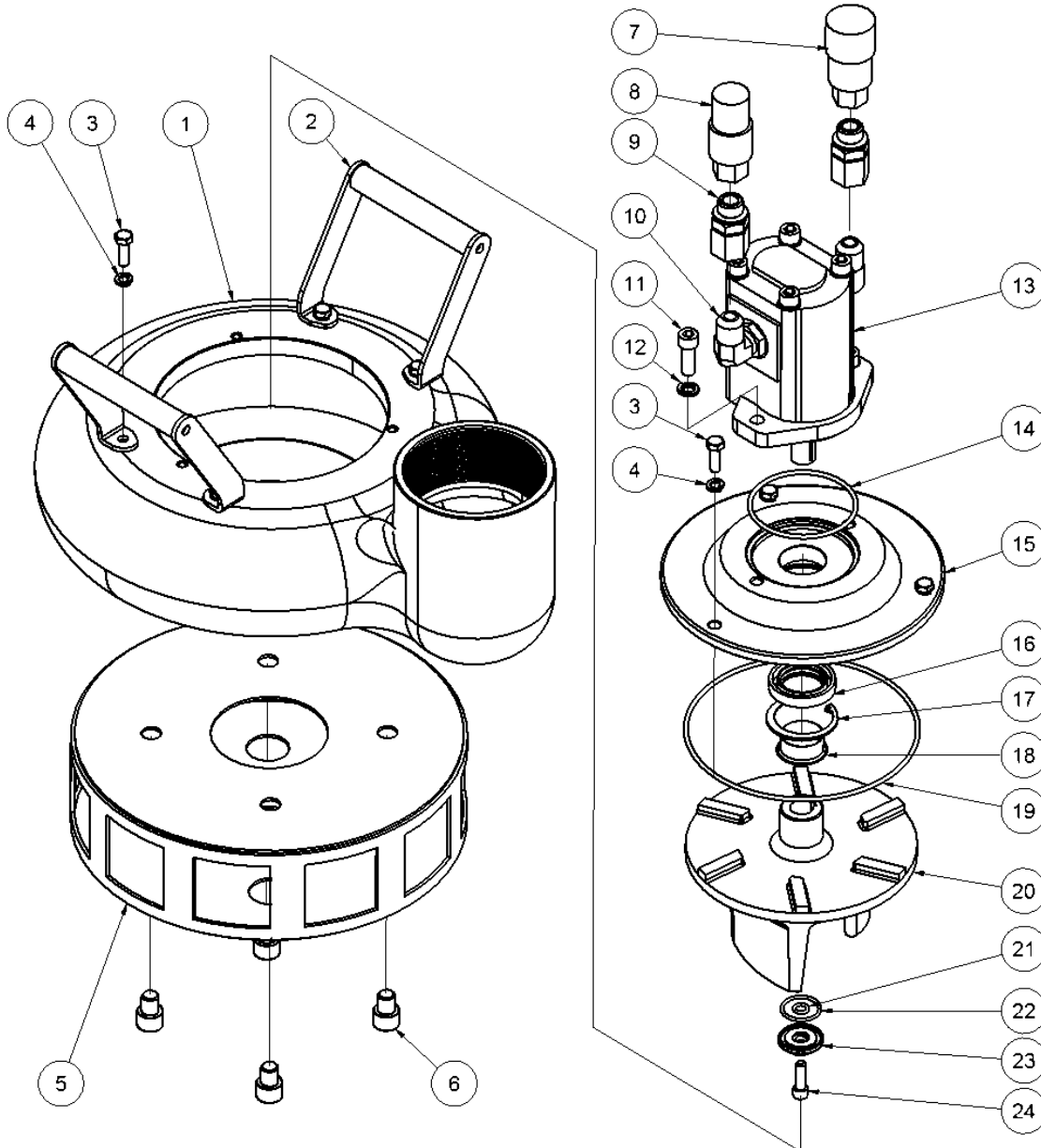

Pos.	Part No.	Description	Pcs.
1	8232714	Volute 4", aluminium	1
2	9932438	Handle	2
3	7632617	Screw M8x25 25 Nm	7
4	7632618	Lock washer M8	7
5	9932456	Strainer	1
6	7632623	Screw M14x16 60 Nm	4
7	7401142	Q.R. coupling 1/2" BSP female	1
8	7401141	Q.R. coupling 1/2" BSP male	1
9	7431185	Straight fitting	2
10	7431184	Elbow fitting	2
11	7632712	Screw M10x30 30 Nm	2
12	7632630	Lock washer M10	2
13	9932437	Hydraulic motor	1
14	9932439	O-ring f/motor	1
15	8232713	Top cover 4", aluminium	1
16	9932442	Shaft seal	1
17	9932444	Retaining ring	1
18	9932443	Seal sleeve <i>Should be changed when changing shaft seal</i>	1
19	9932450	O-ring f/top cover	1
20	9932445	Impeller	1
21	9932447	O-ring ø8.5x2.5	1
22	7531444	O-ring 28x2.5	1
23	9932449	Retaining washer	1
24	9932446	Screw UNC 5/16"x1" 30 Nm	1
-	9932846	Seal kit motor	1